

**ERDOOR**<sup>®</sup>  
*wooden composite door*

Kapı Katalođu  
Door Catalogue

Farklı renk ve modelleriyle montaja hazır olarak üretilen iç mekan Erdoor Kompozit Kapıları, ahşabın sıcak ve estetik görünümünü mekanlarınıza taşır.

*Ready-assembled indoor Erdoor Composite Doors manufactured in different colors and models convey the warm and aesthetic appearance of wood to your living spaces.*

**ERDOOR**<sup>®</sup>  
*wooden composite door*



# FABRİKA FACTORY



Yüzyıllardan beri süregelen ve zaman geçtikçe farklı şekillere bürünen ahşabın hikâyesini evlerinize taşımak için 2011 yılında bu yola çıktık. Ahşap kompozit kapı ve süpürgelik üretimiyle ilk adımlarımızı attığımız sektörde bugün toplamda 2 tesis ve 250 çalışanımızla, 25 ülkeye aktif ihracat gerçekleştirmekteyiz.

Türkiye'de bulunan 18.000 metrekarelik kapalı alan fabrikamızın yanı sıra Cezayir'de bulunan 22.500 metrekarelik tesisimizde, toplamda günlük 2.000 adet kapı ve komponentlerinin üretimini yapmakta ve bu sayede yerel ve uluslararası pazarda söz sahibi olmaktayız.

Günden güne büyüyen yapımla kısa sürede Ortadoğu ve Afrika 'daki en büyük kompozit kapı ve komponentleri üreticisi olma özelliğini taşımaktayız.

Üretim ve pazarlama sürecinin her aşamasında büyük bir özveriyle çalışarak ve üretim yelpazemizi gün geçtikçe genişleterek, "bölgesel güç olma" konusundaki gayemiz ve müşteri memnuniyetini esas alan anlayışımızla çalışmalarımızı canla, başla ve büyük bir sevgiyle sürdürüyoruz.

*In 2011, we set out to bring the story of wood to your homes, which has taken on different shapes for centuries. In the sector, where we took the first steps with the production of wooden composite doors and baseboards, we are actively exporting to 25 countries with 2 plants and 250 employees in total.*

*18,000 square meters of indoor space in Turkey as our factory and 22,500 square meters, our plant in as in Algeria, to make the total daily production of 2,000 units and door components and therefore we are making have a say in local and international markets.*

*With our growing structure day by day that we are the biggest manufacturer of composite doors and components in Africa and Middle East.*

*We work diligently at every stage of the production and marketing process and diligently expanding our production range day by day with the aim of being a "regional power" and based on customer satisfaction.*



# AHŞAP VE PVC'NİN MÜKEMMEL UYUMU!

PERFECT HARMONY OF  
WOOD AND PVC!

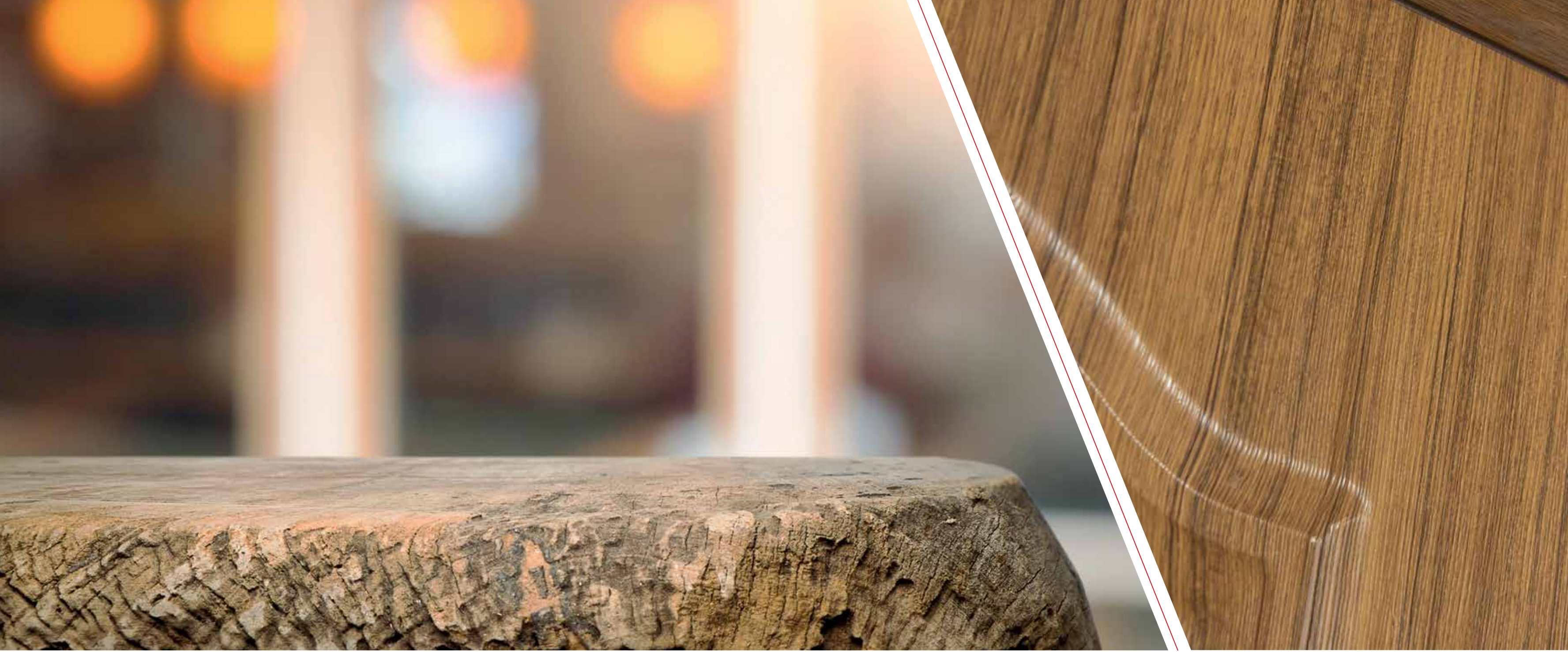

Ahşap talaşı ve PVC hammaddenin birleşimiyle oluşan ERDOOR Kompozit Kapılar, özel üretim teknolojisi ile üretilmektedir. Kompozit kapıların en önemli özelliği; suya, neme, rutubete ve ateşe karşı dayanıklı olmasıdır. Uzun ömürlüdür, böceklenmez ve doğayla dosttur.

*Formed from the combination of sawdust and PVC resin, ERDOOR Composite Doors are manufactured by special production technology. The most important feature of composite doors is resistance to water, moisture, humidity and fire. Besides, it is durable, does not become bug-infested, can be coated and is eco-friendly.*





**SUYA DAYANIKLI**  
WATER RESISTANT



**DARBELERE DAYANIKLI**  
RUBBER RESISTANT

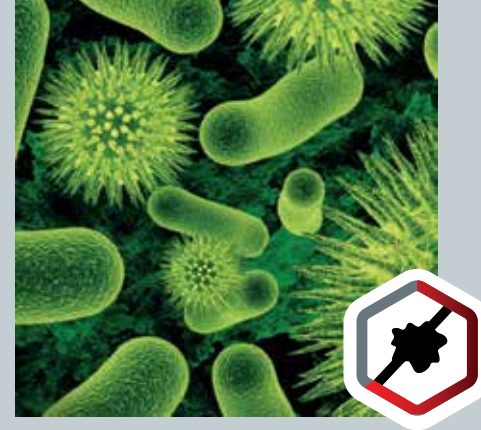

**ANTİ BAKTERİYEL**  
ANTIBACTERIAL



**NEME DAYANIKLI**  
WATER RESISTANT



**BOYA & BAKIM GEREKTİRMEZ**  
PAINT & MAINTENANCE REQUIRED



**B1 YANMAZLIK**  
B1 FIREPROOF

**25 ÜLKE**  
**250 ÇALIŞAN**  
ORTA DOĞU VE AFRİKANIN EN BÜYÜĞÜ  
**25 COUNTRIES**  
**250 EMPLOYEES**  
THE LARGEST IN THE MIDDLE EAST AND AFRICA



Uluslararası Kalite Standartları ve Türk Standartları Enstitüsü'ne uygun olarak üretilen ERDOOR Kompozit Kapılar, sizlere mutluluğun kapısını açacak...

Manufactured in conformity with International Quality Standards and Turkish Standards Institute, ERDOOR Composite Doors will open you the door of happiness...





Tik / Teak  
**ER610**



**0001**  
İtalyan Ceviz /  
Italian Walnut



**0002**  
Koyu Ceviz /  
Dark Walnut



**0005**  
Dışbudak /  
White

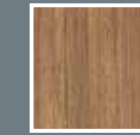

**0006**  
Tik /  
Teak



**0007**  
Beyaz Tik /  
White Teak



**0100**  
Coco /  
Coco



**0101**  
Maaron /  
Maaron

#### **Erdoor Kapı Özellikleri** Specifications of ERDOOR Doors

**Kanat kalınlığı / Leaf thickness**  
40 mm

**Kenar bantları / Pvc edge band**  
1 mm kalınlıktadır / 1 mm thick

**Kanat içi kullanılan dolgular**  
/ Filling types of doors leaf  
Kraft kağıt ve Strafor (EPS)'dur  
/ Honeycomb, Styrofoam (EPS)

**Kullanılan serenler; / Door leaf filling profiles**  
Fingerjointli ahşap seren ve kompozit serendir  
/ Finger Joint wood profiles and composite profiles

Kapılarda sağ-sol yön yoktur  
/ There is no right-left direction on the doors.



SUYA / WATER  
DAYANIKLI / RESISTANT



DARBELERE / RUBBER  
DAYANIKLI / RESISTANT



ANTİBAKTERİYEL / ANTIBACTERIAL



BOYA & BAKIM / PAINT & MAINTENANCE  
GEREKİRMİZ / REQUIRED



B1 / B1  
YANMAZLIK / FIREPROOF

Mix Tik / Mix Teak  
**ER100**

**Erdoor Kapı Özellikleri**  
Specifications of ERDOOR Doors

**Kanat kalınlığı / Leaf thickness**  
40 mm

**Kenar bantları / Pvc edge band**  
1 mm kalınlıktadır / 1 mm thick

**Kanat içi kullanılan dolgular / Filling types of doors leaf**  
Kraft kağıt, Strafor (EPS) ve Okal dolgudur  
/ Honeycomb, Styrofoam (EPS), hollowcore cheapboard & fontex

**Kullanılan serenler; / Door leaf filling profiles**  
Fingerjointli ahşap seren ve kompozit serendir  
/ Finger Joint wood profiles and composite profiles

Kapılarda sağ-sol yön yoktur  
/ There is no right-left direction on the doors.



**0001** İtalyan Ceviz / Italian Walnut  
**0002** Koyu Ceviz / Dark Walnut  
**0005** Dışbudak / White  
**0006** Tik / Teak  
**0007** Beyaz Tik / White Teak  
**0100** Coco / Coco  
**0101** Mauron / Mauron



SUYA / WATER  
DAYANIKLI / RESISTANT



DARBELERE / RUBBER  
DAYANIKLI / RESISTANT



ANTİBAKTERİYEL / ANTIBACTERIAL



BOYA & BAKIM / PAINT & MAINTENANCE  
GEREKTİRMEZ / REQUIRED



B1 / B1  
YANMAZLIK / FIREPROOF

**Erdoor Kapı Özellikleri**  
Specifications of ERDOOR Doors

**Kanat kalınlığı / Leaf thickness**  
40 mm

**Kenar bantları / Pvc edge band**  
1 mm kalınlıktadır / 1 mm thick

Kapılarda sağ-sol yön yoktur  
/ There is no right-left direction on the doors.

**Kanat içi kullanılan dolgular / Filling types of doors leaf**  
Kraft kağıt ve Strafor (EPS)'dur, / Honeycomb, Styrofoam (EPS)

**Kullanılan serenler; / Door leaf filling profiles**  
Fingerjointli ahşap seren ve kompozit serendir  
/ Finger joint wood profiles and composite profiles

Dışbudak / White  
**ER102**



Koyu Ceviz / Dark Walnut  
**ER103**

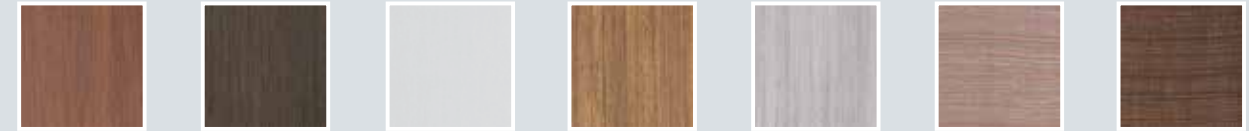

**0001** İtalyan Ceviz / Italian Walnut  
**0002** Koyu Ceviz / Dark Walnut  
**0005** Dışbudak / White  
**0006** Tik / Teak  
**0007** Beyaz Tik / White Teak  
**0100** Coco / Coco  
**0101** Mauron / Mauron



**Erdoor Kapı Özellikleri**  
Specifications of ERDOOR Doors

**Kanat kalınlığı / Leaf thickness**  
40 mm

**Kenar bantları / Pvc edge band**  
1 mm kalınlıktadır / 1 mm thick

Kapılarda sağ-sol yön yoktur

/ There is no right-left direction on the doors.

**Kanat içi kullanılan dolgular / Filling types of doors leaf**  
Kraft kağıt ve Strafor (EPS)'dur. / Honeycomb, Styrofoam (EPS)

**Kullanılan serenler; / Door leaf filling profiles**

Fingerjointli ahşap seren ve kompozit serendir

/ Finger joint wood profiles and composite profiles

İtalyan Ceviz / Italian Walnut

**ER200**



Tik / Teak

**ER201**



**0001**  
İtalyan Ceviz /  
Italian Walnut



**0002**  
Koyu Ceviz /  
Dark Walnut



**0005**  
Dışbudak /  
White



**0006**  
Tik /  
Teak



**0007**  
Beyaz Tik /  
White Teak



**0100**  
Coco /  
Coco

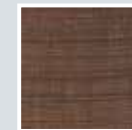

**0101**  
Mauron /  
Mauron

Tik / Teak  
**ER250**



**Erdoor Kapı Özellikleri**  
Specifications of ERDOOR Doors

**Kanat kalınlığı / Leaf thickness**  
40 mm

**Kenar bantları / Pvc edge band**  
1 mm kalınlıktadır / 1 mm thick

**Kanat içi kullanılan dolgular**  
/ Filling types of doors leaf

Kraft kağıt ve Strafor (EPS)'dur

/ Honeycomb, Styrofoam (EPS)

**Kullanılan serenler; / Door leaf filling profiles**

Fingerjointli ahşap seren ve kompozit serendir

/ Finger joint wood profiles and composite profiles

Kapılarda sağ-sol yön yoktur

/ There is no right-left direction on the doors.



**0001**  
İtalyan Ceviz /  
Italian Walnut



**0002**  
Koyu Ceviz /  
Dark Walnut



**0005**  
Dışbudak /  
White

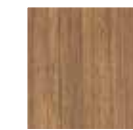

**0006**  
Tik /  
Teak



**0007**  
Beyaz Tik /  
White Teak



**0100**  
Coco /  
Coco



**0101**  
Mauron /  
Mauron



SUYA / WATER  
DAYANIKLI / RESISTANT



DARBELERE / RUBBER  
DAYANIKLI / RESISTANT



ANTİBAKTERİYEL / ANTIBACTERIAL



BOYA & BAKIM / PAINT & MAINTENANCE  
GEREKİTİRMEZ / REQUIRED



B1 / B1  
YANMAZLIK / FIREPROOF



**Erdoor Kapı Özellikleri**  
Specifications of ERDOOR Doors

**Kanat kalınlığı / Leaf thickness**  
40 mm

**Kenar bantları / Pvc edge band**  
1 mm kalınlıktadır / 1 mm thick

Kapılarda sağ-sol yön yoktur  
/ There is no right-left direction on the doors.

**Kanat içi kullanılan dolgular / Filling types of doors leaf**  
Kraft kağıt ve Strafor (EPS)'dur, / Honeycomb, Styrofoam (EPS)

**Kullanılan serenler; / Door leaf filling profiles**  
Fingerjointli ahşap seren ve kompozit serendir  
/ Finger joint wood profiles and composite profiles

Görselde kullanılan pervaz 35x150 mm'dir.  
35x150 mm architrave are used on this model

**Koyu Ceviz / Dark Walnut**  
**ER260**



**Dışbudak / White**  
**ER261**

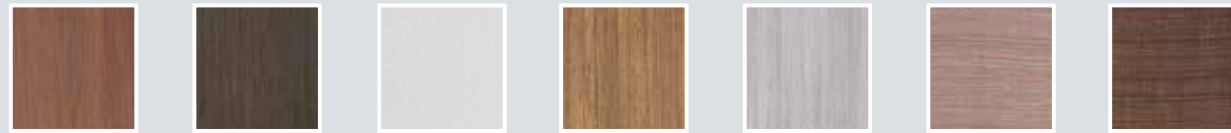

**0001** İtalyan Ceviz / Italian Walnut  
**0002** Koyu Ceviz / Dark Walnut  
**0005** Dışbudak / White  
**0006** Tik / Teak  
**0007** Beyaz Tik / White Teak  
**0100** Coco / Coco  
**0101** Mauron / Mauron



SUYA / WATER  
DAYANIKLI / RESISTANT



DARBELERE / RUBBER  
DAYANIKLI / RESISTANT



ANTİBAKTERİYEL / ANTIBACTERIAL



BOYA & BAKIM / PAINT & MAINTENANCE  
GEREKİTİRMEZ / REQUIRED



B1 / B1  
YANMAZLIK / FIREPROOF

**Erdoor Kapı Özellikleri**  
Specifications of ERDOOR Door

**Kanat kalınlığı / Leaf thickness**  
40 mm

**Kenar bantları / Pvc edge band**  
1 mm kalınlıktadır / 1 mm thick

Kapılarda sağ-sol yön yoktur  
/ There is no right-left direction on the doors.

**Kanat içi kullanılan dolgular / Filling types of doors leaf**  
Kraft kağıt ve Strafor (EPS)'dur, / Honeycomb, Styrofoam (EPS)

**Kullanılan serenler; / Door leaf filling profiles**  
Fingerjointli ahşap seren ve kompozit serendir  
/ Finger joint wood profiles and composite profiles

**Tik / Teak**  
**ER300**



**Beyaz Tik / White Teak**  
**ER301**



**0001** İtalyan Ceviz / Italian Walnut  
**0002** Koyu Ceviz / Dark Walnut  
**0005** Dışbudak / White  
**0006** Tik / Teak  
**0007** Beyaz Tik / White Teak  
**0100** Coco / Coco  
**0101** Mauron / Mauron



SUYA / WATER  
DAYANIKLI / RESISTANT



DARBELERE / RUBBER  
DAYANIKLI / RESISTANT



ANTİBAKTERİYEL / ANTIBACTERIAL



BOYA & BAKIM / PAINT & MAINTENANCE  
GEREKİTİRMEZ / REQUIRED



B1 / B1  
YANMAZLIK / FIREPROOF

**Erdoor Kapı Özellikleri**  
Specifications of ERDOOR Doors

**Kanat kalınlığı / Leaf thickness**  
40 mm

**Kenar bantları / Pvc edge bad**  
1 mm kalınlıktadır / 1 mm thick

Kapılarda sağ-sol yön yoktur  
/ There is no right-left direction on the doors.

**Kanat içi kullanılan dolgular / Filling types of doors leaf**  
Kraft kağıt ve Strafor (EPS)'dur. / Honeycomb, Styrofoam (EPS)

**Kullanılan serenler; / Door leaf filling profiles**  
Fingerjointli ahşap seren ve kompozit serendir  
/ Finger joint wood profiles and composite profiles

Görselde kullanılan pervaz oval pervazdır.  
The moldings used in the visual are oval moldings.

**Tik / Teak**  
**ER600**



**Beyaz Tik / White Teak**  
**ER601**

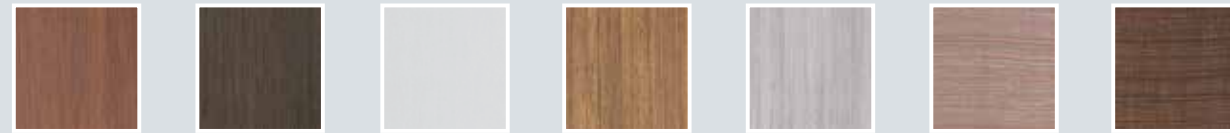

**0001** İtalyan Ceviz / Italian Walnut  
**0002** Koyu Ceviz / Dark Walnut  
**0005** Dışbudak / White  
**0006** Tik / Teak  
**0007** Beyaz Tik / White Teak  
**0100** Coco / Coco  
**0101** Mauron / Mauron

**Koyu Ceviz / Dark Walnut**  
**ER602**

Görselde kullanılan pervaz 35x150 mm'dir.  
35x150 mm architrave are used on this model



**Erdoor Kapı Özellikleri**  
Specifications of ERDOOR Door

**Kanat kalınlığı / Leaf thickness**  
40 mm

**Kenar bantları / Pvc edge band**  
1 mm kalınlıktadır / 1 mm thick

**Kanat içi kullanılan dolgular / Filling types of doors leaf**  
Kraft kağıt ve Strafor (EPS)'dur.  
/ Honeycomb, Styrofoam (EPS)

**Kullanılan serenler; / Door leaf filling profiles**  
Fingerjointli ahşap seren ve kompozit serendir  
/ Finger joint wood profiles and composite profiles

**Fleksi renk çeşitleri / Flexi color assortment**  
Altın, Gümüş / Gold, Silver

Kapılarda sağ-sol yön yoktur  
/ There is no right-left direction on the doors.



**0001** İtalyan Ceviz / Italian Walnut  
**0002** Koyu Ceviz / Dark Walnut  
**0005** Dışbudak / White  
**0006** Tik / Teak  
**0007** Beyaz Tik / White Teak  
**0100** Coco / Coco  
**0101** Mauron / Mauron



SUYA DAYANIKLI / WATER RESISTANT  
DARBELERE DAYANIKLI / RUBBER RESISTANT  
ANTİBAKTERİYEL / ANTIBACTERIAL  
BOYA & BAKIM GEREKTİRMEZ / PAINT & MAINTENANCE REQUIRED  
B1 YANMAZLIK / FIREPROOF



**Kanat içi kullanılan dolgular / Filling types of doors leaf**  
Kraft kağıt ve Strafor (EPS)'dur / Honeycomb, Styrofoam (EPS)

**Kullanılan serenler; / Door leaf filling profiles**  
Fingerjointli ahşap seren ve kompozit serendir  
/ Finger joint wood profiles and composite profiles

**Erdor Kapı Özellikleri**  
Specifications of ERDOOR Doors

**Kanat kalınlığı / Leaf thickness**  
40 mm

**Kenar bantları / Pvc Edge Band**  
1 mm kalınlıktadır / 1 mm thick

**Fleksi renk çeşitleri / Flexi color assortment**  
Altın, Gümüş / Gold, Silver

Kapılarda sağ- sol yön yoktur  
/ There is no right-left direction on the doors.

Tik / Teak  
**ER610**



Tik / Teak  
**ER610** çift kanat Double Leaf



**0001**  
İtalyan Ceviz /  
Italian Walnut



**0002**  
Koyu Ceviz /  
Dark Walnut



**0005**  
Dışbudak /  
White

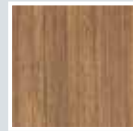

**0006**  
Tik /  
Teak



**0007**  
Beyaz Tik /  
White Teak



**0100**  
Coco /  
Coco

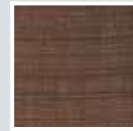

**0101**  
Mauron /  
Mauron

Beyaz Tik / White Teak  
**ER620**



**Erdor Kapı Özellikleri**  
Specifications of ERDOOR Doors

**Kanat kalınlığı / Leaf thickness**  
40 mm

**Kenar bantları / Pvc edge band**  
1 mm kalınlıktadır / 1 mm thick

**Kanat içi kullanılan dolgular / Filling types of doors leaf**  
Kraft kağıt ve Strafor (EPS)'dur,  
/ Honeycomb, Styrofoam (EPS)

**Kullanılan serenler; / Door leaf filling profiles**  
Fingerjointli ahşap seren ve kompozit serendir  
/ Finger joint wood profiles and composite profiles

Kapılarda sağ-sol yön yoktur  
/ There is no right-left direction on the doors.



**0001**  
İtalyan Ceviz /  
Italian Walnut



**0002**  
Koyu Ceviz /  
Dark Walnut



**0005**  
Dışbudak /  
White



**0006**  
Tik /  
Teak



**0007**  
Beyaz Tik /  
White Teak



**0100**  
Coco /  
Coco



**0101**  
Mauron /  
Mauron



SUYA / WATER  
DAYANIKLI / RESISTANT



DARBELERE / RUBBER  
DAYANIKLI / RESISTANT



ANTİBAKTERİYEL / ANTIBACTERIAL



BOYA & BAKIM / PAINT & MAINTENANCE  
GEREKİTİRMEZ / REQUIRED



B1 / B1  
YANMAZLIK / FIREPROOF

**Erdor Kapı Özellikleri**  
Specifications of ERDOOR Doors

**Kanat kalınlığı / Leaf thickness**  
40 mm

**Kenar bantları / Pvc edge band**  
1 mm kalınlıktadır / 1 mm thick

Kapılarda sağ- sol yön yoktur  
/ There is no right-left direction on the doors.

**Kanat içi kullanılan dolgular / Filling types of doors leaf**  
Kraft kağıt ve Strafor (EPS)'dur / Honeycomb, Styrofoam (EPS)

**Kullanılan serenler; / Door leaf filling profiles**  
Fingerjointli ahşap seren ve kompozit serendir  
/ Finger joint wood profiles and composite profiles

Görselde kullanılan pervaz 35x150 mm'dir.  
35x150 mm architrave are used on this model

**Koyu Ceviz / Dark Walnut**  
**ER800**



**Tik / Teak**  
**ER801**

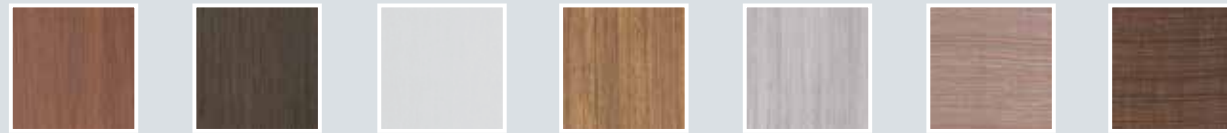

**0001** İtalyan Ceviz / Italian Walnut  
**0002** Koyu Ceviz / Dark Walnut  
**0005** Dışbudak / White  
**0006** Tik / Teak  
**0007** Beyaz Tik / White Teak  
**0100** Coco / Coco  
**0101** Mauron / Mauron



**Erdor Kapı Özellikleri**  
Specifications of ERDOOR Door

**Kanat kalınlığı / Leaf thickness**  
40 mm

**Kenar bantları / Pvc edge band**  
1 mm kalınlıktadır / 1 mm thick

Kapılarda sağ- sol yön yoktur  
/ There is no right-left direction on the doors.

**Kanat içi kullanılan dolgular / Filling types of doors leaf**  
Kraft kağıt ve Strafor (EPS)'dur, / Honeycomb, Styrofoam (EPS)

**Kullanılan serenler; / Door leaf filling profiles**  
Fingerjointli ahşap seren ve kompozit serendir  
/ Finger joint wood profiles and composite profiles

**Dışbudak / White**  
**ER900**



**İtalyan Ceviz / Italian Walnut**  
**ER901**

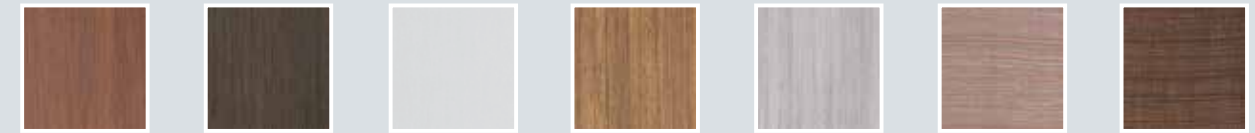

**0001** İtalyan Ceviz / Italian Walnut  
**0002** Koyu Ceviz / Dark Walnut  
**0005** Dışbudak / White  
**0006** Tik / Teak  
**0007** Beyaz Tik / White Teak  
**0100** Coco / Coco  
**0101** Mauron / Mauron





**Erdor Kapı Özellikleri**  
Specifications of ERDOOR Doors

**Kanat kalınlığı / Leaf thickness**  
40 mm

**Kenar bantları / Pvc edge band**  
1 mm kalınlıktadır / 1 mm thick

Kapılarda sağ- sol yön yoktur  
/ There is no right-left direction on the doors.

**Kanat içi kullanılan dolgular / Filling types of doors leaf**  
Kraft kağıt ve Strafor (EPS)'dur / Honeycomb, Styrofoam (EPS)

**Kullanılan serenler; / Door leaf filling profiles**  
Fingerjointli ahşap seren ve kompozit serendir  
/ Finger joint wood profiles and composite profiles

Görselde kullanılan pervaz 35x150 mm'dir.  
35x150 mm architrave are used on this model

**Tik / Teak**  
**ER950**



**Koyu Ceviz / Dark Walnut**  
**ER951**



**0001** İtalyan Ceviz / Italian Walnut  
**0002** Koyu Ceviz / Dark Walnut  
**0005** Dışbudak / White  
**0006** Tik / Teak  
**0007** Beyaz Tik / White Teak  
**0100** Coco / Coco  
**0101** Mauron / Mauron

**İtalyan Ceviz / Italian Walnut**  
**ER1004**

**Erdor Kapı Özellikleri**  
Specifications of ERDOOR Door

**Kanat kalınlığı / Leaf thickness**  
40 mm

**Kenar bantları / Pvc edge band**  
1 mm kalınlıktadır / 1 mm thick

**Kanat içi kullanılan dolgular / Filling types of doors leaf**  
Kraft kağıt ve Strafor (EPS)'dur,  
/ Honeycomb, Styrofoam (EPS)

**Kullanılan serenler; / Door leaf filling profiles**  
Fingerjointli ahşap seren ve kompozit serendir  
/ Finger joint wood profiles and composite profiles

Kapılarda sağ-sol yön yoktur  
/ There is no right-left direction on the doors.



**0001** İtalyan Ceviz / Italian Walnut  
**0002** Koyu Ceviz / Dark Walnut  
**0005** Dışbudak / White  
**0006** Tik / Teak  
**0007** Beyaz Tik / White Teak  
**0100** Coco / Coco  
**0101** Mauron / Mauron



Tik / Teak  
**ER1006**

**Erdoor Kapı Özellikleri**  
Specifications of ERDOOR Door

**Kanat kalınlığı / Leaf thickness**  
40 mm

**Kenar bantları / Pvc edge band**  
1 mm kalınlıktadır / 1 mm thick

**Kanat içi kullanılan dolgular**  
/ Filling types of doors leaf  
Kraft kağıt ve Strafor (EPS)'dur,  
/ Honeycomb, Styrofoam (EPS)

**Kullanılan serenler; / Door leaf filling profiles**  
Fingerjointli ahşap seren ve kompozit serendir  
/ Finger joint wood profiles and composite profiles

Kapılarda sağ-sol yön yoktur  
/ There is no right-left direction on the doors.



Dışbudak / White  
**ER1008**

**Erdoor Kapı Özellikleri**  
Specifications of ERDOOR Door

**Kanat kalınlığı / Leaf thickness**  
40 mm

**Kenar bantları / Pvc edge band**  
1 mm kalınlıktadır / 1 mm thick

**Kanat içi kullanılan dolgular**  
/ Filling types of doors leaf  
Kraft kağıt ve Strafor (EPS)'dur,  
/ Honeycomb, Styrofoam (EPS)

**Kullanılan serenler; / Door leaf filling profiles**  
Fingerjointli ahşap seren ve kompozit serendir  
/ Finger joint wood profiles and composite profiles

Kapılarda sağ-sol yön yoktur  
/ There is no right-left direction on the doors.



0001 İtalyan Ceviz / Italian Walnut  
0002 Koyu Ceviz / Dark Walnut  
0005 Dışbudak / White  
0006 Tik / Teak  
0007 Beyaz Tik / White Teak  
0100 Coco / Coco  
0101 Mauron / Mauron



SUYA / WATER  
DAYANIKLI / RESISTANT



DARBELERE / RUBBER  
DAYANIKLI / RESISTANT



ANTİBAKTERİYEL / ANTIBACTERIAL



BOYA & BAKIM / PAINT & MAINTENANCE  
GEREKİRMİZ / REQUIRED



B1 / B1  
YANMAZLIK / FIREPROOF



0001 İtalyan Ceviz / Italian Walnut  
0002 Koyu Ceviz / Dark Walnut  
0005 Dışbudak / White  
0006 Tik / Teak  
0007 Beyaz Tik / White Teak  
0100 Coco / Coco  
0101 Mauron / Mauron



SUYA / WATER  
DAYANIKLI / RESISTANT



DARBELERE / RUBBER  
DAYANIKLI / RESISTANT



ANTİBAKTERİYEL / ANTIBACTERIAL



BOYA & BAKIM / PAINT & MAINTENANCE  
GEREKİRMİZ / REQUIRED



B1 / B1  
YANMAZLIK / FIREPROOF



Beyaz Tik / White Teak  
**ER1012**

**Erdoor Kapı Özellikleri**  
Specifications of ERDOOR Door

**Kanat kalınlığı / Leaf thickness**  
40 mm

**Kenar bantları / Pvc edge band**  
1 mm kalınlıktadır / 1 mm thick

**Kanat içi kullanılan dolgular**  
/ Filling types of doors leaf  
Kraft kağıt ve Strafor (EPS)'dur,  
/ Honeycomb, Styrofoam (EPS)

**Kullanılan serenler; / Door leaf filling profiles**  
Fingerjointli ahşap seren ve kompozit serendir  
/ Finger joint wood profiles and composite profiles

**Fleksi renk çeşitleri / Flexi color assortment**  
Altın, gümüş ve antrasit  
Gold, silver and anthracite

Kapılarda sağ-sol yön yoktur  
/ There is no right-left direction on the doors.



Koyu Ceviz / Dark Walnut  
**ER1014**

**Erdoor Kapı Özellikleri**  
Specifications of ERDOOR Door

**Kanat kalınlığı / Leaf thickness**  
40 mm

**Kenar bantları / Pvc edge band**  
1 mm kalınlıktadır / 1 mm thick

**Kanat içi kullanılan dolgular**  
/ Filling types of doors leaf  
Kraft kağıt ve Strafor (EPS)'dur,  
/ Honeycomb, Styrofoam (EPS)

**Kullanılan serenler; / Door leaf filling profiles**  
Fingerjointli ahşap seren ve kompozit serendir  
/ Finger joint wood profiles and composite profiles

**Fleksi renk çeşitleri / Flexi color assortment**  
Altın, gümüş ve antrasit  
Gold, silver and anthracite

Kapılarda sağ-sol yön yoktur  
/ There is no right-left direction on the doors.



0001 İtalyan Ceviz / Italian Walnut  
0002 Koyu Ceviz / Dark Walnut  
0005 Dışbudak / White  
0006 Tik / Teak  
0007 Beyaz Tik / White Teak  
0100 Coco / Coco  
0101 Mauron / Mauron



SUYA DAYANIKLI / WATER RESISTANT



DARBELERE DAYANIKLI / RUBBER RESISTANT



ANTİBAKTERİYEL / ANTIBACTERIAL



BOYA & BAKIM GEREKTİRMEZ / PAINT & MAINTENANCE REQUIRED



B1 YANMAZLIK / B1 FIREPROOF



0001 İtalyan Ceviz / Italian Walnut  
0002 Koyu Ceviz / Dark Walnut  
0005 Dışbudak / White  
0006 Tik / Teak  
0007 Beyaz Tik / White Teak  
0100 Coco / Coco  
0101 Mauron / Mauron



SUYA DAYANIKLI / WATER RESISTANT



DARBELERE DAYANIKLI / RUBBER RESISTANT



ANTİBAKTERİYEL / ANTIBACTERIAL



BOYA & BAKIM GEREKTİRMEZ / PAINT & MAINTENANCE REQUIRED



B1 YANMAZLIK / B1 FIREPROOF

**Koyu Ceviz / Dark Walnut**  
**ER2000**

**Erdoor Kapı Özellikleri**  
**Specifications of ERDOOR Door**

**Kanat kalınlığı / Leaf thickness**  
40 mm

**Kenar bantları / Pvc edge band**  
1 mm kalınlıktadır / 1 mm thick

**Kanat içi kullanılan dolgular**  
**/ Filling types of doors leaf**  
Strafor (EPS) ve Okal dolgudur  
**/ Styrofoam (EPS), hollowcore cheapboard & fontex**

**Kullanılan serenler; / Door leaf filling profiles**  
Fingerjointli ahşap seren ve kompozit serendir  
**/ Finger joint wood profiles and composite profiles**

Alüminyum çita kullanılmaktadır  
**/ Aluminum stitich are used**

Kapılarda sağ-sol yön yoktur  
**/ There is no right-left direction on the doors.**



**0001** İtalyan Ceviz / Italian Walnut  
**0002** Koyu Ceviz / Dark Walnut  
**0005** Dışbudak / White  
**0006** Tik / Teak  
**0007** Beyaz Tik / White Teak  
**0100** Coco / Coco  
**0101** Mauron / Mauron



SUYA DAYANIKLI / WATER RESISTANT



DARBELERE DAYANIKLI / RUBBER RESISTANT



ANTİBAKTERİYEL / ANTIBACTERIAL



BOYA & BAKIM GEREKTİRMEZ / PAINT & MAINTENANCE REQUIRED



B1 YANMAZLIK / B1 FIREPROOF

**Erdoor Kapı Özellikleri**  
**Specifications of ERDOOR Door**

**Kanat kalınlığı / Leaf thickness**  
40 mm

**Kenar bantları / Pvc edge band**  
1 mm kalınlıktadır / 1 mm thick

Kapılarda sağ-sol yön yoktur  
**/ There is no right-left direction on the doors.**

Alüminyum çita kullanılmaktadır /  
Aluminum stitich are used

**Kanat içi kullanılan dolgular / Filling types of doors leaf**  
Strafor(EPS) ve Okal dolgudur  
**/ Styrofoam (EPS), hollowcore cheapboard & fontex**

**Kullanılan serenler; / Door leaf filling profiles**  
Fingerjointli ahşap seren ve kompozit serendir  
**/ Finger joint wood profiles and composite profiles**

Görselde kullanılan pervaz taç pervazdır.  
Tiara architrave are used on this model

**Mauron / Mauron**  
**ER2002**



**Koyu Ceviz / Dark Walnut**  
**ER2003**

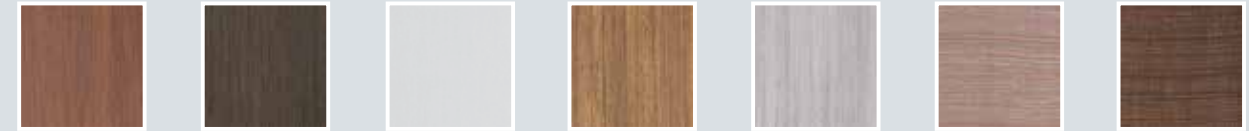

**0001** İtalyan Ceviz / Italian Walnut  
**0002** Koyu Ceviz / Dark Walnut  
**0005** Dışbudak / White  
**0006** Tik / Teak  
**0007** Beyaz Tik / White Teak  
**0100** Coco / Coco  
**0101** Mauron / Mauron



Beyaz Tik / White Teak  
**ER5000**

**Erdoor Kapı Özellikleri**  
Specifications of ERDOOR Door

**Kanat kalınlığı / Leaf thickness**

Dış çerçevesi 42 mm / Orta Kısım 35mm  
/ On this model door leaf thickness 35 mm after U profile door leaf thickness are coming 42 mm.

**Kenar bantları / Pvc edge band**

Kenar bantlama yoktur,  
kompozit kanat kenarı kullanılmaktadır  
/ On this model we do not use edge band.  
We use composite U profile

**Kanat içi kullanılan dolgular**

**/ Filling types of doors leaf**  
Strafor (EPS)'dur / Styrofoam (EPS)

**Kullanılan serenler; / Door leaf filling profiles**

Fingerjointli ahşap seren  
/ Finger joint wood profiles

Kapılarda sağ-sol yön yoktur

/ There is no right-left direction on the doors.



**0001**  
İtalyan Ceviz /  
Italian Walnut

**0002**  
Koyu Ceviz /  
Dark Walnut

**0005**  
Dışbudak /  
White

**0006**  
Tik /  
Teak

**0007**  
Beyaz Tik /  
White Teak

**0100**  
Coco /  
Coco

**0101**  
Mauron /  
Mauron



SUYA  
DAYANIKLI / WATER  
RESISTANT



DARBELERE  
DAYANIKLI / RUBBER  
RESISTANT



ANTİBAKTERİYEL /  
ANTIBACTERIAL



BOYA & BAKIM  
GEREKTİRMEZ / PAINT & MAINTENANCE  
REQUIRED



B1  
YANMAZLIK / B1  
FIREPROOF

**ER5000 Serisi Kapı Modelleri Teknik Detaylar**  
ER5000 Series Door Models Technical Details

Kompozit U Profili /  
Composite U profile

Strafor / Styrofoam (EPS)

Pvc Levha / Pvc Sheet

Pvc Folyo / Pvc Foil

Pvc Renk Tabakası /  
Pvc Color Layer

Kanat Üst Çıtası /  
Leaf Top Composite Molding

Yüzey Koruma Filmi /  
Pvc Protection Gelatinx

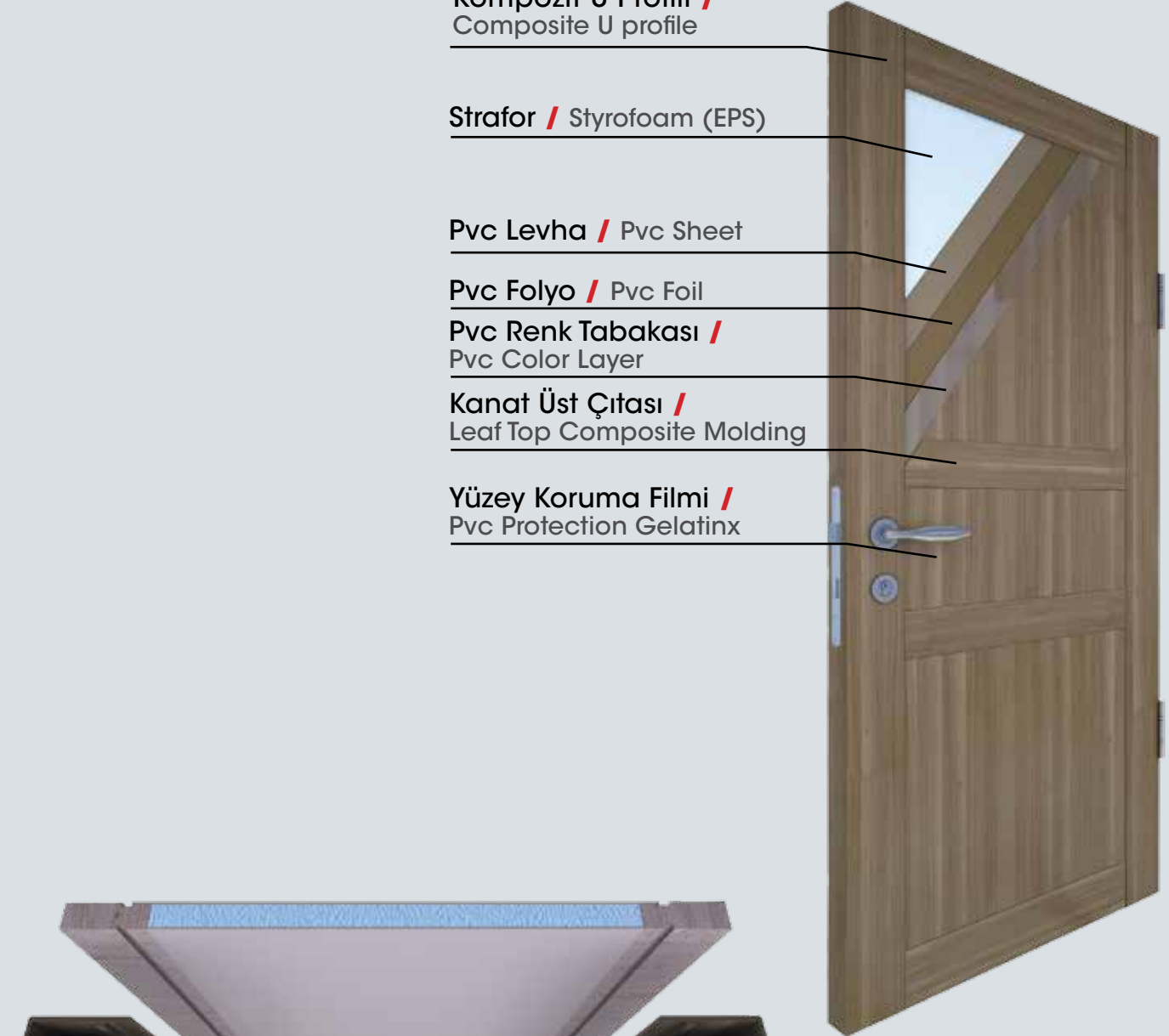

Kompozit U Profili /  
Composite U profile

Tik / Teak  
**ER5012**

**Erdoor Kapı Özellikleri**  
**Specifications of ERDOOR Door**

**Kanat kalınlığı / Leaf thickness**

Dış çerçevesi 42 mm / Orta Kısım 35mm  
/ On this model door leaf thickness 35 mm after U profile door leaf thickness are coming 42 mm.

**Kenar bantları / Pvc edge band**

Kenar bantlama yoktur,  
kompozit kanat kenarı kullanılmaktadır  
/ On this model we do not use edge band.  
We use composite U profile

**Kanat içi kullanılan dolgular**

**/ Filling types of doors leaf**  
Strafor (EPS)'dur / Styrofoam (EPS)

**Kullanılan serenler; / Door leaf filling profiles**

Fingerjointli ahşap seren  
/ Finger joint wood profiles

**Kapılarda sağ-sol yön yoktur**

/ There is no right-left direction on the doors.



**0001** İtalyan Ceviz / Italian Walnut  
**0002** Koyu Ceviz / Dark Walnut  
**0005** Dışbudak / White  
**0006** Tik / Teak  
**0007** Beyaz Tik / White Teak  
**0100** Coco / Coco  
**0101** Mauron / Mauron



SUYA / WATER  
DAYANIKLI / RESISTANT



DARBELERE / RUBBER  
DAYANIKLI / RESISTANT



ANTİBAKTERİYEL / ANTIBACTERIAL



BOYA & BAKIM / PAINT & MAINTENANCE  
GEREKİTİRMEZ / REQUIRED



B1 / B1  
YANMAZLIK / FIREPROOF

Beyaz Tik / White Teak  
**ER5014**

**Erdoor Kapı Özellikleri**  
**Specifications of ERDOOR Door**

**Kanat kalınlığı / Leaf thickness**

Dış çerçevesi 42 mm / Orta Kısım 35mm  
/ On this model door leaf thickness 35 mm after U profile door leaf thickness are coming 42 mm.

**Kenar bantları / Pvc edge band**

Kenar bantlama yoktur,  
kompozit kanat kenarı kullanılmaktadır  
/ On this model we do not use edge band.  
We use composite U profile

**Kanat içi kullanılan dolgular**

**/ Filling types of doors leaf**  
Strafor (EPS)'dur / Styrofoam (EPS)

**Kullanılan serenler; / Door leaf filling profiles**

Fingerjointli ahşap seren  
/ Finger joint wood profiles

**Kapılarda sağ-sol yön yoktur**

/ There is no right-left direction on the doors.



**0001** İtalyan Ceviz / Italian Walnut  
**0002** Koyu Ceviz / Dark Walnut  
**0005** Dışbudak / White  
**0006** Tik / Teak  
**0007** Beyaz Tik / White Teak  
**0100** Coco / Coco  
**0101** Mauron / Mauron



SUYA / WATER  
DAYANIKLI / RESISTANT



DARBELERE / RUBBER  
DAYANIKLI / RESISTANT



ANTİBAKTERİYEL / ANTIBACTERIAL



BOYA & BAKIM / PAINT & MAINTENANCE  
GEREKİTİRMEZ / REQUIRED



B1 / B1  
YANMAZLIK / FIREPROOF



Coco / Coco  
**ER5020**

**Erdoor Kapı Özellikleri**  
**Specifications of ERDOOR Door**

**Kanat kalınlığı / Leaf thickness**

Dış çerçevesi 42 mm / Orta Kısım 35mm  
/ On this model door leaf thickness 35 mm after U profile door leaf thickness are coming 42 mm.

**Kenar bantları / Pvc edge band**

Kenar bantlama yoktur,  
kompozit kanat kenarı kullanılmaktadır  
/ On this model we do not use edge band.  
We use composite U profile

**Kanat içi kullanılan dolgular**

**/ Filling types of doors leaf**  
Strafor (EPS)'dur / Styrofoam (EPS)

**Kullanılan serenler; / Door leaf filling profile**

Fingerjointli ahşap serendir  
/ Finger joint wood profiles

**Kapılarda sağ-sol yön yoktur**

/ There is no right-left direction on the doors.



Mauron / Mauron  
**ER5030**

**Erdoor Kapı Özellikleri**  
**Specifications of ERDOOR Door**

**Kanat kalınlığı / Leaf thickness**

Dış çerçevesi 42 mm / Orta Kısım 35 mm  
On this model door leaf thickness 35 mm after U profile door leaf thickness are coming 42 mm.

**Kenar bantları / Pvc edge band**

Kenar bantlama yoktur,  
kompozit kanat kenarı kullanılmaktadır  
/ On this model we do not use edge band.  
We use composite U profile.

**Kanat içi kullanılan dolgular**

**/ Filling types of doors leaf**  
Strafor (EPS)'dur / Styrofoam (EPS)

**Kullanılan serenler; / Door leaf filling profiles**

Fingerjointli ahşap serendir  
/ Finger joint wood profiles

**Kapılarda sağ- sol yön yoktur**

/ There is no right-left direction on the doors.



**0001**  
İtalyan Ceviz /  
Italian Walnut

**0002**  
Koyu Ceviz /  
Dark Walnut

**0005**  
Dışbudak /  
White

**0006**  
Tik /  
Teak

**0007**  
Beyaz Tik /  
White Teak

**0100**  
Coco /  
Coco

**0101**  
Mauron /  
Mauron



SUYA / WATER  
DAYANIKLI / RESISTANT



DARBELERE / RUBBER  
DAYANIKLI / RESISTANT



ANTİBAKTERİYEL /  
ANTIBACTERIAL



BOYA & BAKIM / PAINT & MAINTENANCE  
GEREKİRMİZ / REQUIRED



B1 / B1  
YANMAZLIK / FIREPROOF



**0001**  
İtalyan Ceviz /  
Italian Walnut

**0002**  
Koyu Ceviz /  
Dark Walnut

**0005**  
Dışbudak /  
White

**0006**  
Tik /  
Teak

**0007**  
Beyaz Tik /  
White Teak

**0100**  
Coco /  
Coco

**0101**  
Mauron /  
Mauron



SUYA / WATER  
DAYANIKLI / RESISTANT



DARBELERE / RUBBER  
DAYANIKLI / RESISTANT



ANTİBAKTERİYEL /  
ANTIBACTERIAL



BOYA & BAKIM / PAINT & MAINTENANCE  
GEREKİRMİZ / REQUIRED



B1 / B1  
YANMAZLIK / FIREPROOF

Dışbudak / White  
**ER5040**

**Erdoor Kapı Özellikleri**  
Specifications of ERDOOR Door

**Kanat kalınlığı / Leaf thickness**

Dış çerçevesi 42 mm / Orta Kısım 35mm  
/ On this model door leaf thickness 35 mm after  
U profile door leaf thickness are coming 42 mm

**Kenar bantları / Pvc edge band**

Kenar bantlama yoktur,  
kompozit kanat kenarı kullanılmaktadır  
/ On this model we do not use edge band.  
We use composite U profile.

**Kanat içi kullanılan dolgular**

**/ Filling types of doors leaf**  
Strafor (EPS)'dur / Styrofoam (EPS)

**Kullanılan serenler; / Door leaf filling profiles**

Fingerjointli ahşap serendir  
/ Finger joint wood profiles

Kapılarda sağ-sol yön yoktur

/ There is no right-left direction on the doors.



Mauron / Mauron  
**ER5050**

Görselde kullanılan pervaz taç pervazdır.  
Tiara architrave are used on this model

**Erdoor Kapı Özellikleri**  
Specifications of ERDOOR Door

**Kanat kalınlığı / Leaf thickness**

Dış çerçevesi 42 mm / Orta Kısım 35mm  
On this model door leaf thickness 35 mm after  
U profile door leaf thickness are coming 42 mm.

**Kenar bantları / Pvc edge band**

Kenar bantlama yoktur,  
kompozit kanat kenarı kullanılmaktadır  
/ On this model we do not use edge band.  
We use composite U profile

**Kanat içi kullanılan dolgular**

**/ Filling types of doors leaf**  
Strafor (EPS)'dur / Styrofoam (EPS)

**Kullanılan serenler; / Door leaf filling profiles**

Fingerjointli ahşap serendir / Finger joint wood profiles

Kapılarda sağ- sol yön yoktur

/ There is no right-left direction on the doors.



0001 İtalyan Ceviz / Italian Walnut  
0002 Koyu Ceviz / Dark Walnut  
0005 Dışbudak / White  
0006 Tik / Teak  
0007 Beyaz Tik / White Teak  
0100 Coco / Coco  
0101 Mauron / Mauron



0001 İtalyan Ceviz / Italian Walnut  
0002 Koyu Ceviz / Dark Walnut  
0005 Dışbudak / White  
0006 Tik / Teak  
0007 Beyaz Tik / White Teak  
0100 Coco / Coco  
0101 Mauron / Mauron







# TÜRKAK YANGIN DAYANIKLILIĞI SERTİFİKALI



## YANGINA DAYANIKLI KAPI FIRE RESISTANT DOOR

\*30 dk. boyunca yangına dayanıklıdır. /  
\*Fire resistant for 30 minutes

### Erdoor Kapı Özellikleri Specifications of ERDOOR Doors

**Kanat kalınlığı / Leaf thickness**  
44 mm

**MDF yüzeyler / MDF Surface**  
3 mm kalınlıktadır / 3 mm thick

**Kenar bantları / Pvc edge band**  
1 mm kalınlıktadır / 1 mm thick

**Kullanılan serenler; / Door leaf filling profiles**  
Sert ağaçlardan gürgen veya kayın serenidir  
/ Hard wood profile

**Kanat içi kullanılan dolgular  
/ Filling types of doors leaf**  
Yangına dayanıklı 38 mm yonga levhadır  
/ Fire resistant 38 mm chipboard

**Kullanılan diğer ürün ve aksesuarlar; /  
Other products and accessories used;**  
Giyotin, dürbün, harici kapatici, yanmaz conta,  
yanmaz fırçalı fitil, yanmaz menteşe, intumesan levha,  
yanmaz mastik, corner saeal reddiPLEX  
/ Guillotine, binoculars, external concealer, fireproof  
gasket, fireproof brush roving, fireproof hinge, intumes-  
cent sheet, fireproof sealant, corner saeal reddiPLEX

Kapılarda sağ- sol yön vardır.  
/ Doors have left-right direction



SUYA  
DAYANIKLI / WATER  
RESISTANT



DARBELERE  
DAYANIKLI / RUBBER  
RESISTANT



ANTİBAKTERİYEL /  
ANTIBACTERIAL



BOYA & BAKIM  
GEREKİTİRMEZ / PAINT & MAINTENANCE  
REQUIRED



B1 / B1  
YANMAZLIK / FIREPROOF



**0001**  
İtalyan Ceviz /  
Italian Walnut



**0002**  
Koyu Ceviz /  
Dark Walnut



**0005**  
Dışbudak /  
White



**0006**  
Tik /  
Teak



**0007**  
Beyaz Tik /  
White Teak



**0100**  
Coco /  
Coco



**0101**  
Mauron /  
Mauron

**Teknik Özellikler / Technical Details**

**Yangına Dayanıklı Kapı Yardımcı Elemanları /  
Fire Resistant Door Accessories**

Ahşap seren (sert ağaç) /  
Wood profile (hard wood)

Yangına dayanıklı yonga levha /  
Fire rited sheet

Mdf Yüzey / Mdf Surcafe

Pvc Folyo / Pvc Foil

Pvc renk tabakası /  
Pvc color layer

Yüzey koruma filmi /  
Pvc protection gelatinx

Duman fitili /  
Smoke wick

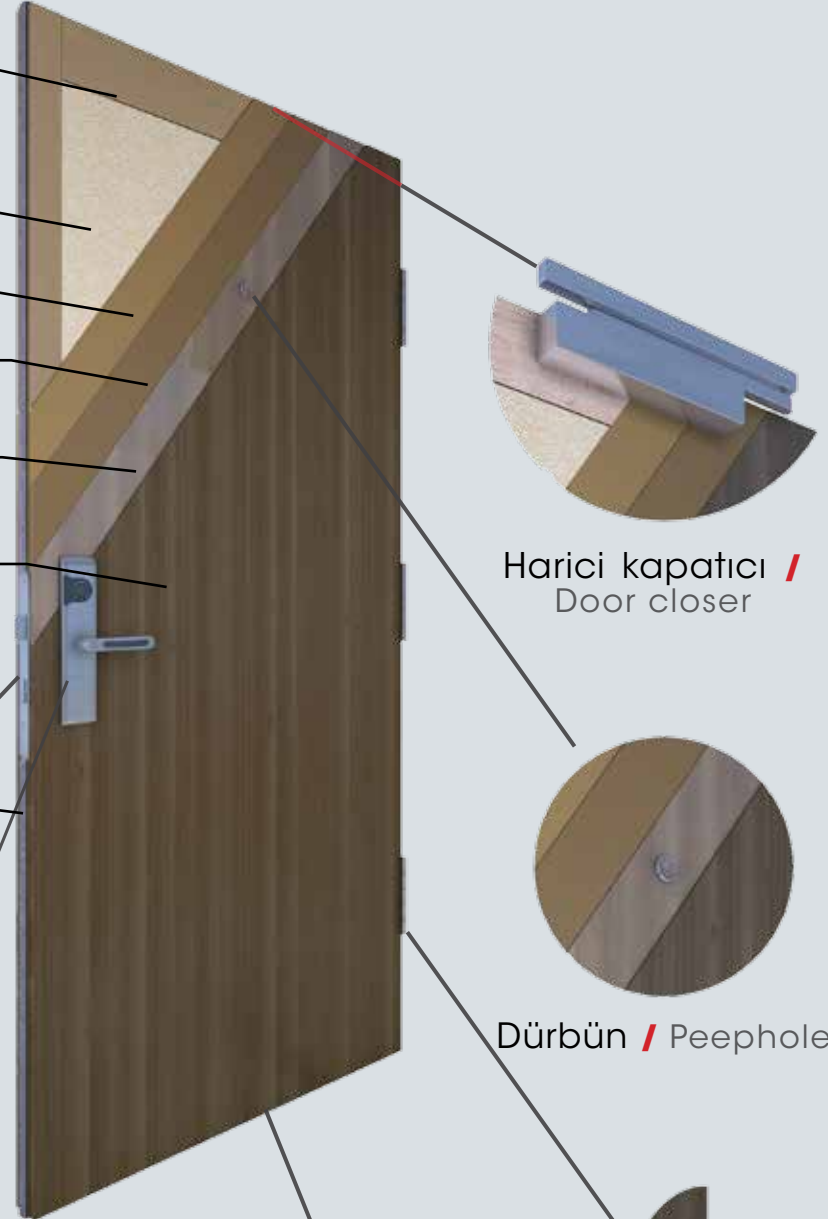

Harici kapatıcı /  
Door closer

Dürbün / Peephole

Kilit / Lock

Kapı kolu /  
Door handle

Giyotin / Giotin

Menteşe /  
Hinge

**Kapı Yönleri / Swing Direction**

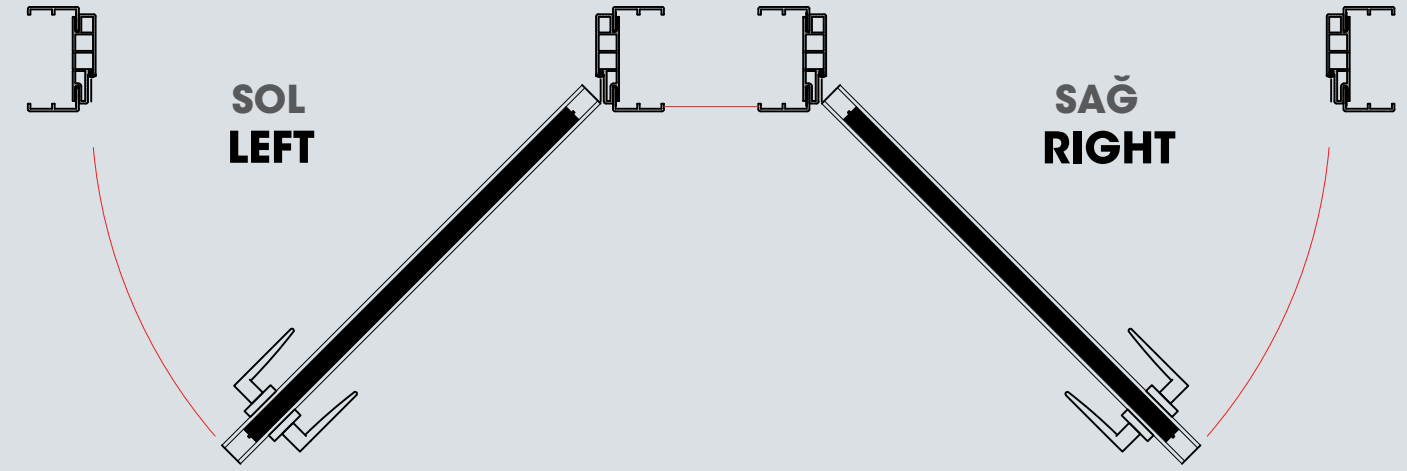

**Yangına Dayanıklı Kapı Sertifikalar /  
Certificates of Fire Resistant Door**





**Kompozit Seren, Strafor Dolgulu Kapı Katmanları /**  
*Composite Filling Technical Details*

Kompozit seren /  
Composite profiles

Strafor / Styrofoam (EPS)

Pvc levha / Pvc sheet

Pvc folyo / Pvc foil

Pvc renk tabakası / Pvc color layer

Yüzey koruma filmi /  
Pvc protection gelatinx



**Okal Dolgu Kapı Katmanları /**  
*Cheapboard Filling Technical Details*

Ahşap seren /  
Wood profiles

Okal yonga levha /  
Cheapboard sheet

Pvc levha / Pvc sheet

Pvc folyo / Pvc foil

Pvc renk tabakası /  
Pvc color layer

Yüzey koruma filmi /  
Pvc protection gelatinx



**Kraft Dolgu Kapı Katmanları /**  
*Honeycomb Filling Technical Details*

Ahşap seren /  
Wood profiles

Kraft kağıt /  
Honeycomb

Pvc levha / Pvc sheet

Pvc folyo / Pvc foil

Pvc renk tabakası /  
Pvc color layer

Yüzey koruma filmi /  
Pvc protection gelatinx



Kanat / Leaf

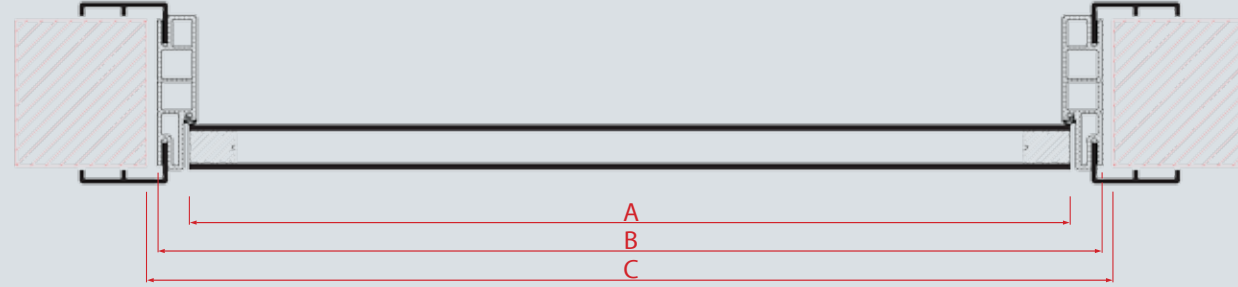

KANAT LEAF A	KASA DIŐ EXTERNAL MEASURE OF FRAME	MONTAJ BOŐLUĐU OPENING SIZE C	
		Min.	Max.
650	703	723	773
700	753	763	813
750	803	813	863
800	853	863	913
850	903	913	963
900	953	963	1013

Kasa ve Pervazları / Door Frames and Architrave

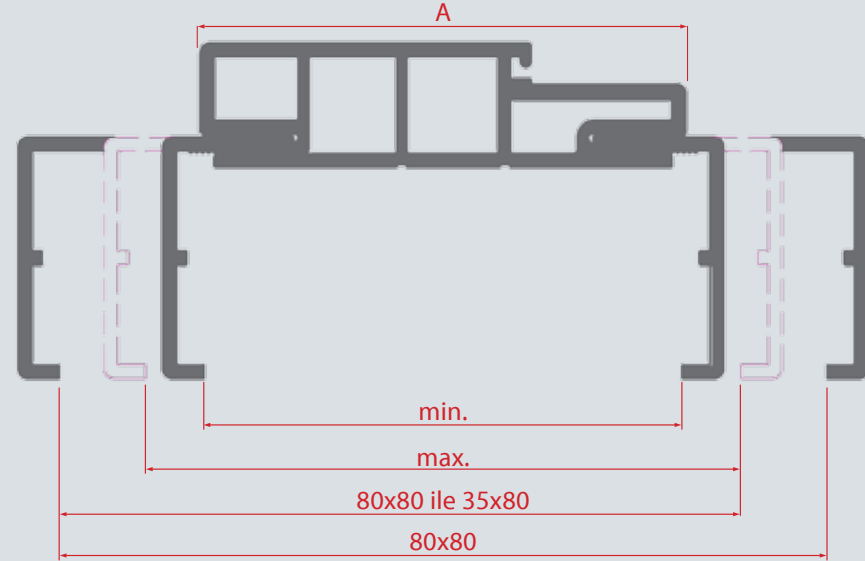

PERVAZ ARCHITRAVE 35x80	KASA / FRAME								
	A	70	100	120	140	160	180	200	240
Min.	67	97	117	137	157	177	197	237	
Max.	102	132	152	172	192	212	232	272	
35x80 + 80x80	127	157	177	197	217	237	257	297	
80x80 + 80x80	152	182	202	222	242	262	282	322	

Pervaz tipine göre kanat yüksekliĐi tablosu

/ Height of our doors according to architrave

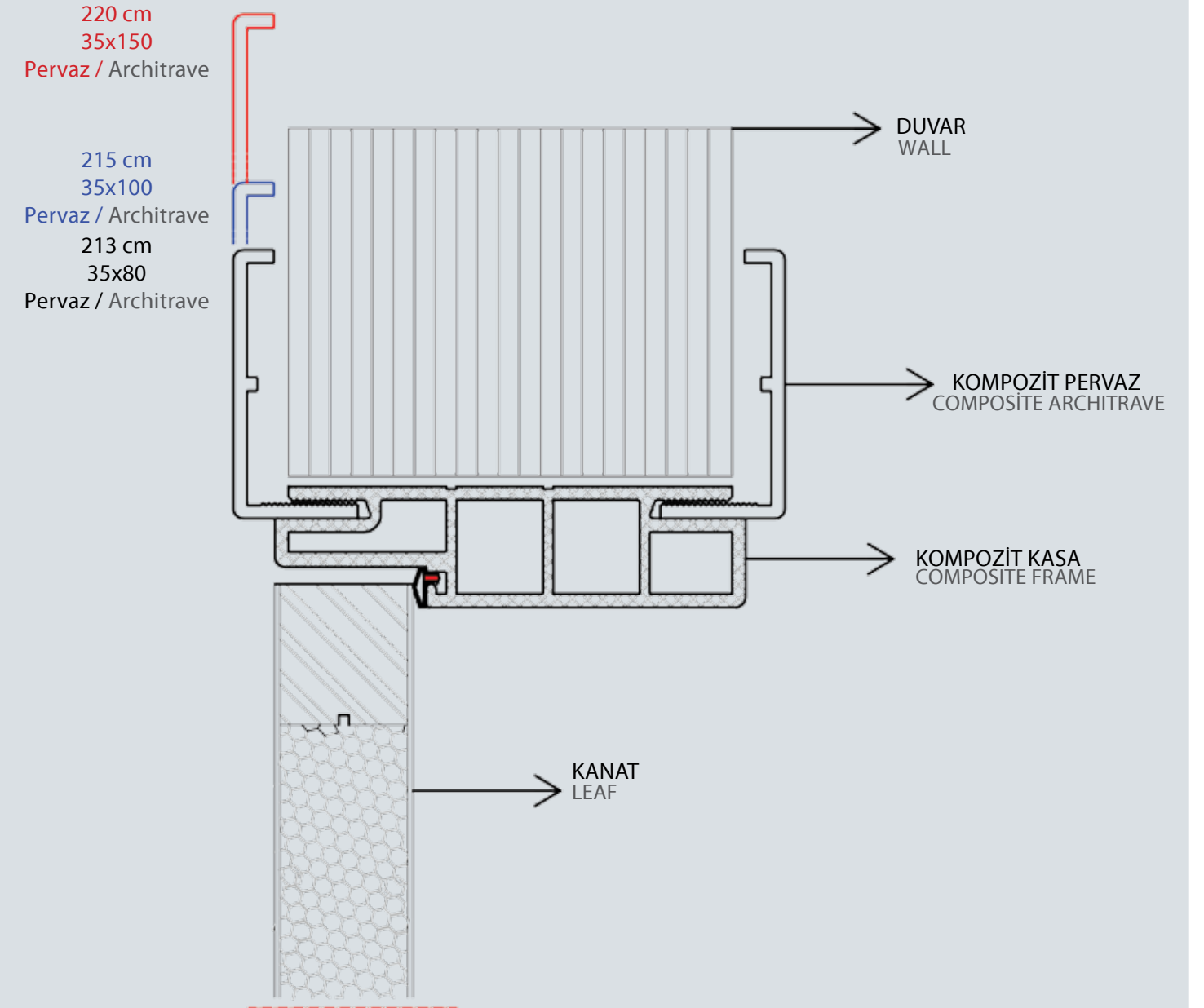

KANAT YÜKSEKLİĐİ LEAF HIGHT	PERVAZ TİPİ ARCHITRAVE TYPE	MAX. KAPI YÜKSEKLİĐİ MAX DOOR HIGHT
202 cm	35x80 mm	213 cm
202 cm	35x100 mm	215 cm
202 cm	35x150 mm	220 cm
220 cm	35x80 mm	231 cm
220 cm	35x100 mm	233 cm
220 cm	35x150 mm	238 cm



**Cam Çita Modeli / Glazing Bead Model**

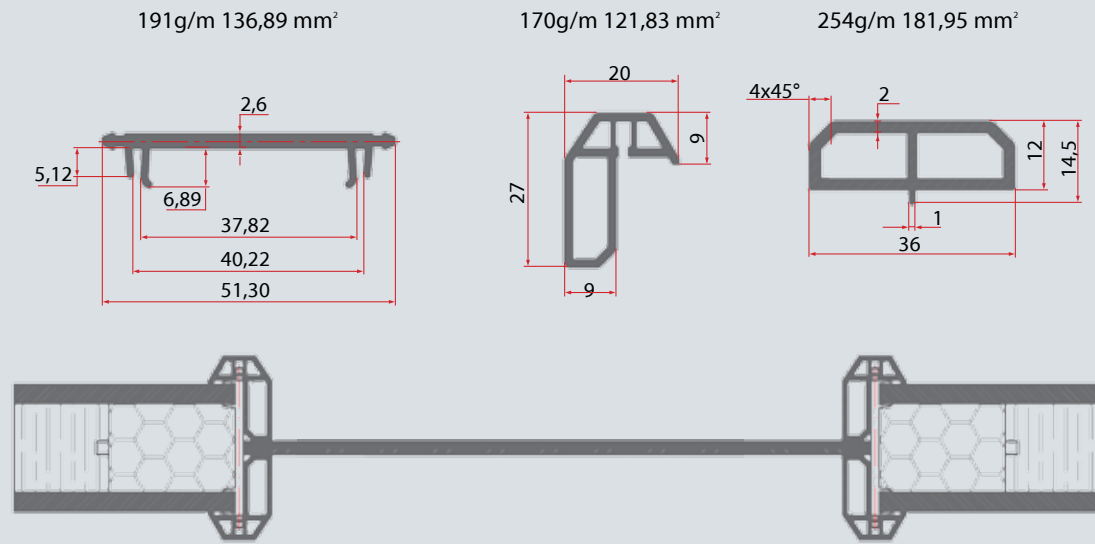

**Pervaz Modeli / Architrave Teyp**

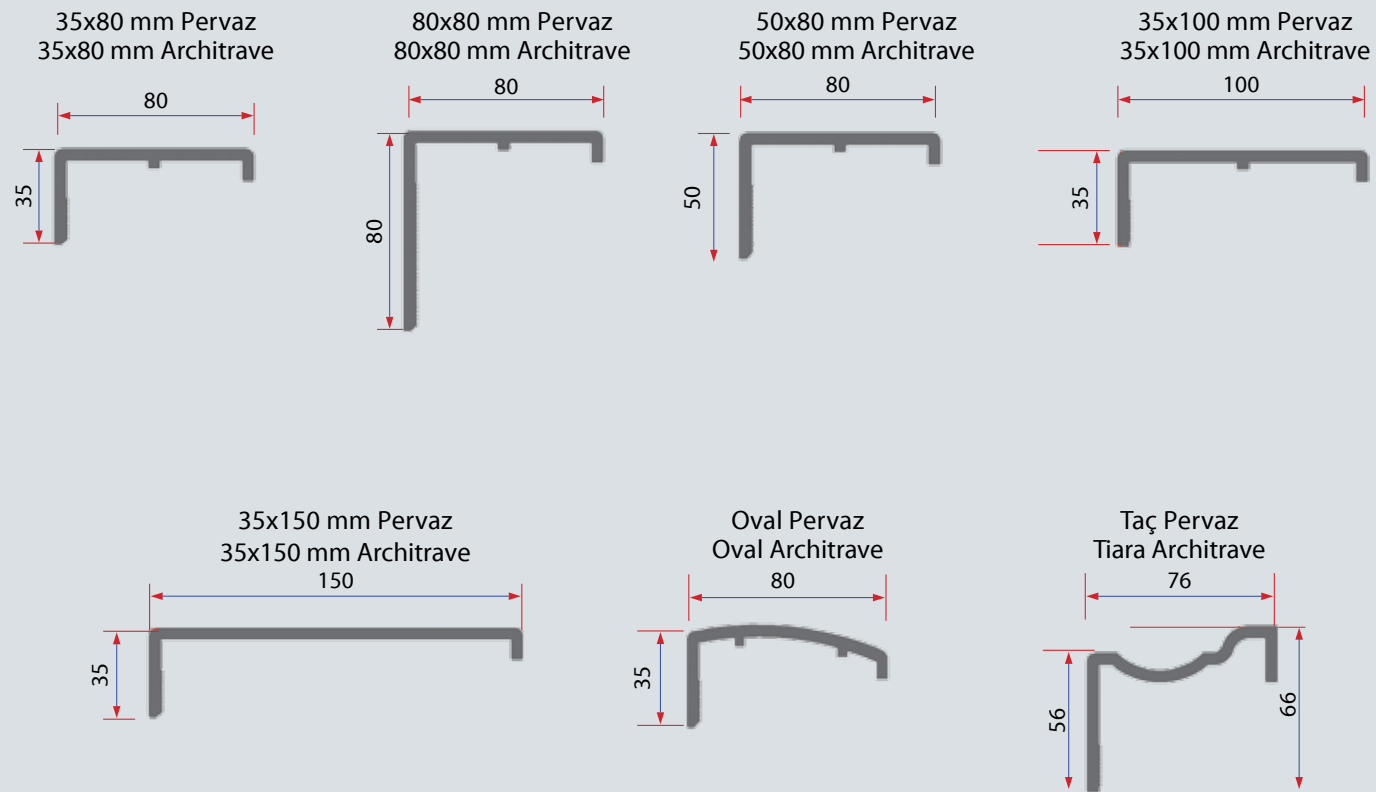

**Kasa ve Pervazları / Door Frames and Architrave**

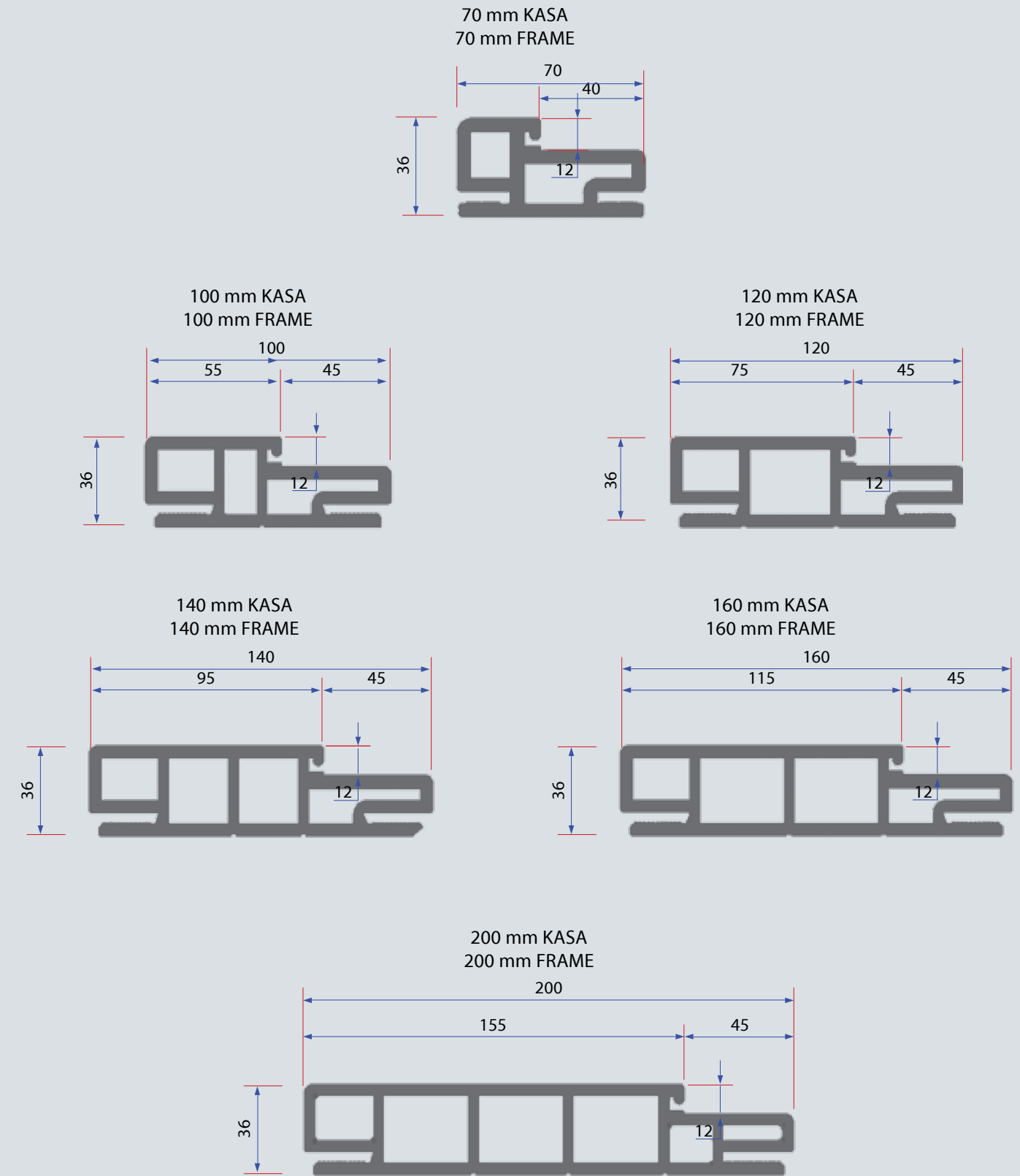

**Kablolar artık dert değil!**

Erdoor'un ürettiği yeni süpürgelik sistemiyle; kablolar artık dert değil. Modüler yapıya sahip sistemimiz sayesinde mekanlarınızda sıkıntı oluşturan tüm kabloları süpürgeliklerinizin içinden geçiriyor ve size konforlu mekanlar sağlıyoruz.

**Cables are no more trouble!**

Cables are no more trouble thanks to new plinth system produced by Erdoor. We put all your cables inside the plinths thanks to our modular system and offer you comfortable living spaces.

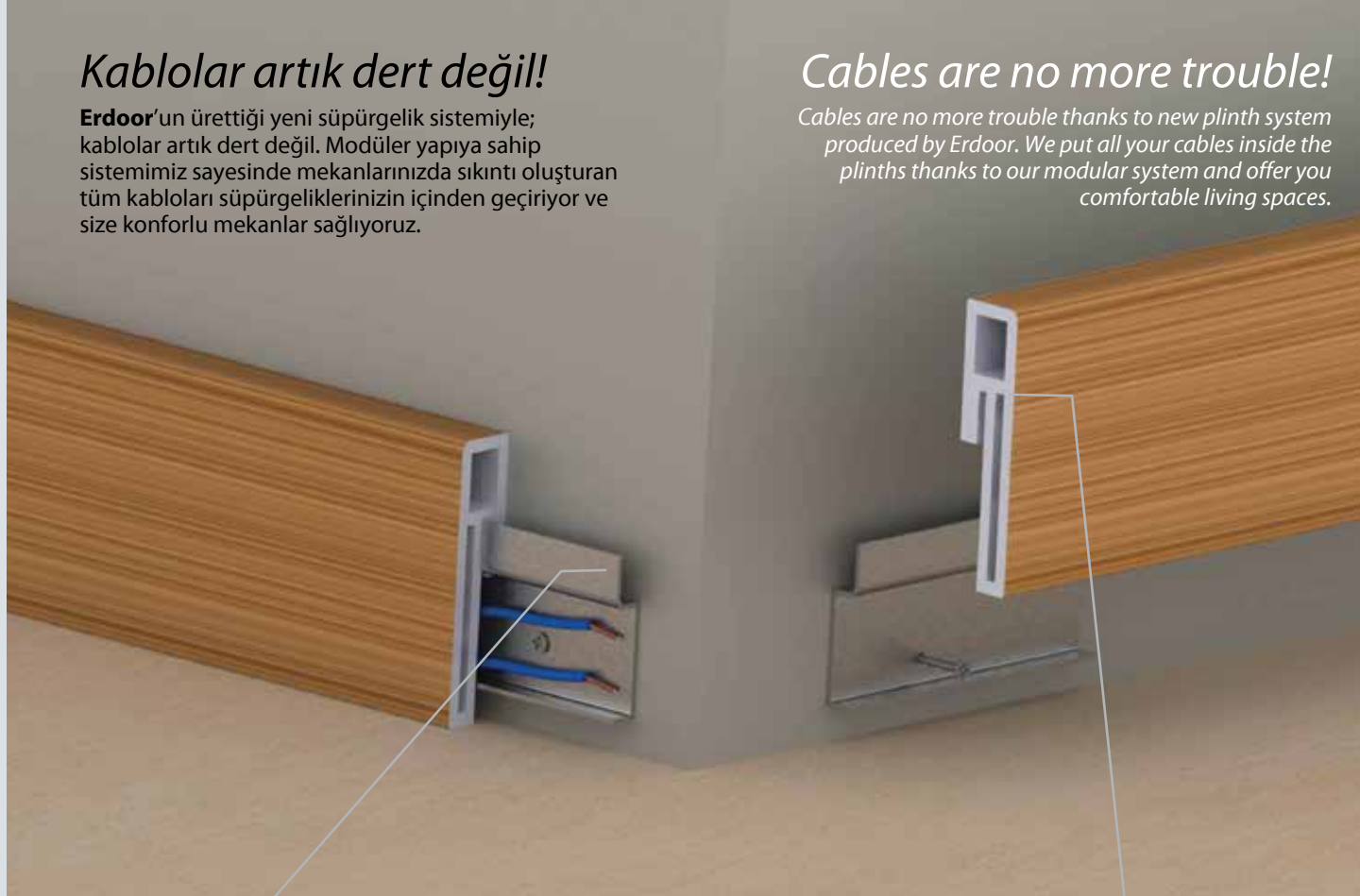

**Gizli Bağlantı Aparatı**  
/ Hidden Connection Apparatus

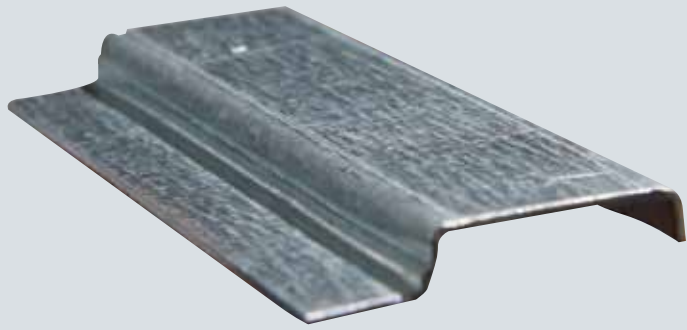

**Kompozit Süpürgelik**  
/ Composite Plinths

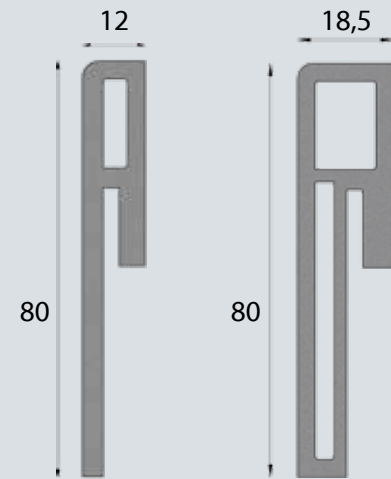

**444 0 270**

erdoor.com.tr

Katalog No: 5



**ERDOOR**<sup>®</sup>  
*wooden composite door*



ERDOORVASTI.COM

**444 0 270**

**erdoor.com.tr**

**Türkiye / Turkey**  
E-5 Çevreyolu üzeri  
Kırıkhan / HATAY  
0326 345 40 60 (pbx)  
444 0 270 [info@erdoor.com.tr](mailto:info@erdoor.com.tr)

**Cezayir / Algeria**  
Ouled Brahim N'03 Sect 05 GP 892  
Alger / Algeria  
+213 560 46 58 30 (pbx) [algeria@erdoor.com.tr](mailto:algeria@erdoor.com.tr)

 **ERGUNBAS**  
Group  
[ergunbas.com](http://ergunbas.com)